

Rockfon Canva® Panneau mural

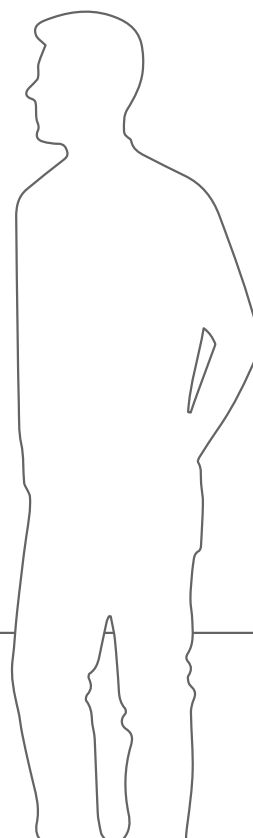
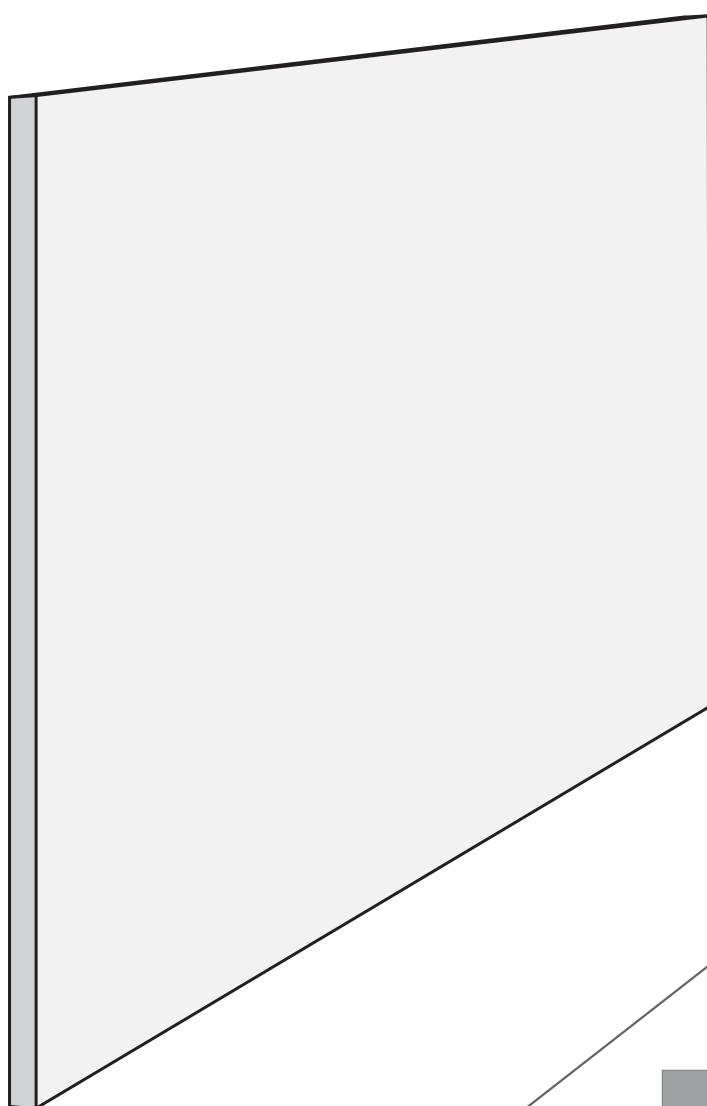

Outils	Perceuse	Visseuse	Mètre	Laser	Niveau
					

Installation (4 étapes au total)

1 Fixez les supports muraux à l'aide des vis.

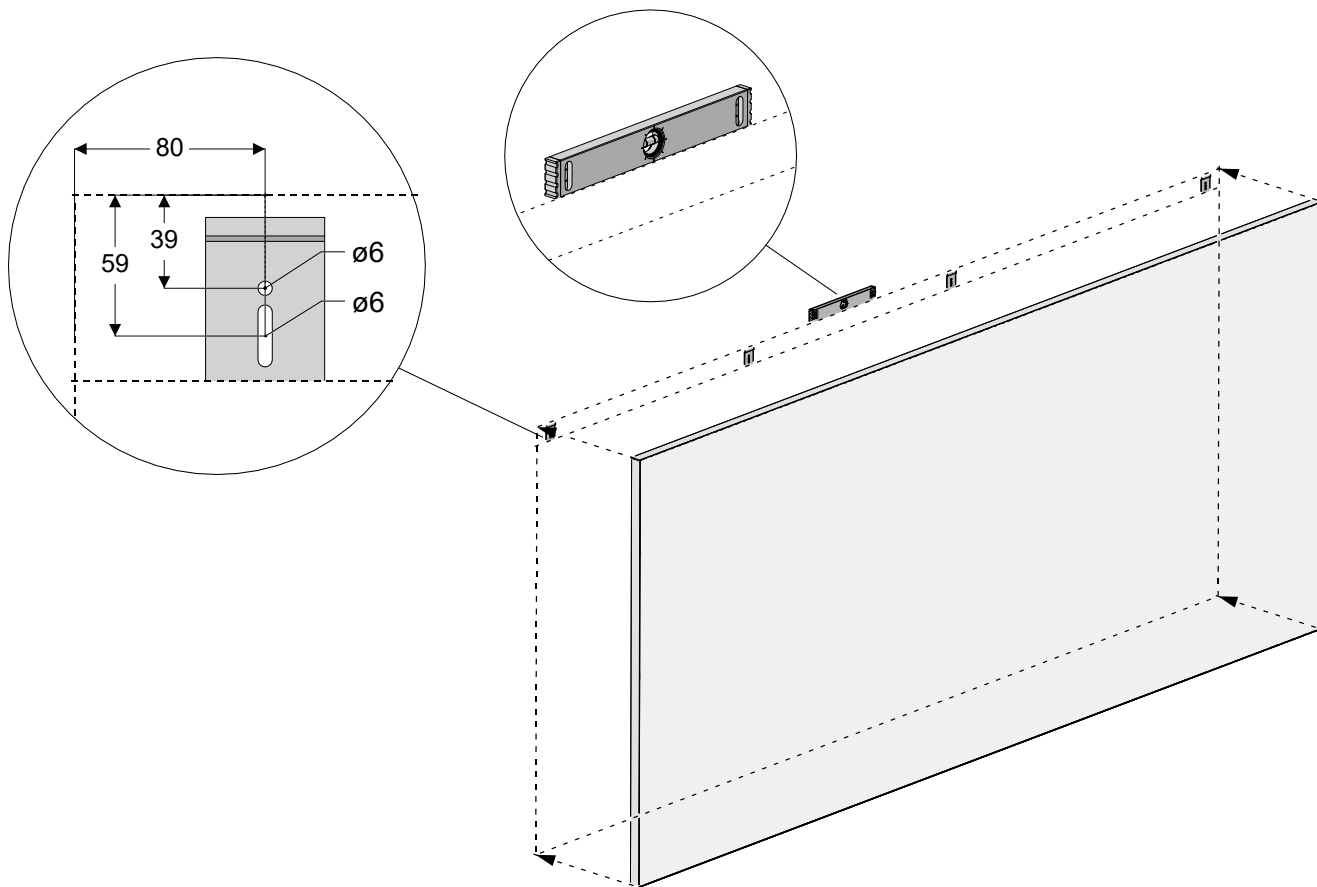

Les supports muraux ne sont pas nécessaires si la dimension est < 600 mm

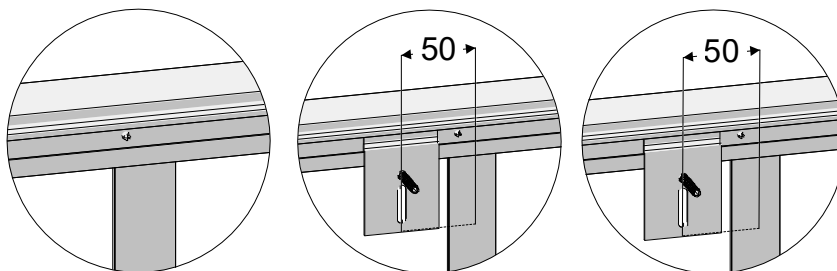

Les supports muraux sont obligatoires à côté d'un connecteur en I (profilé vertical).

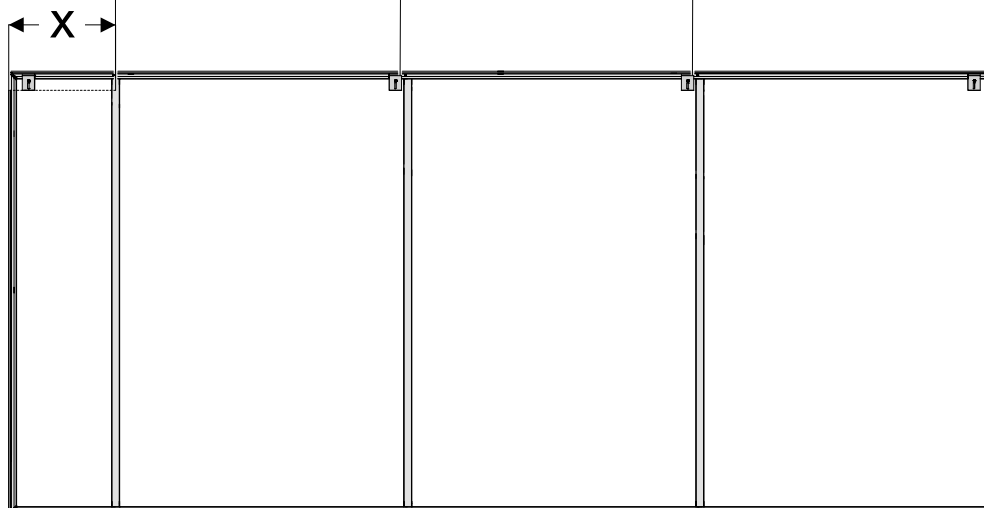

2 Installez le panneau mural sur les supports mureaux.

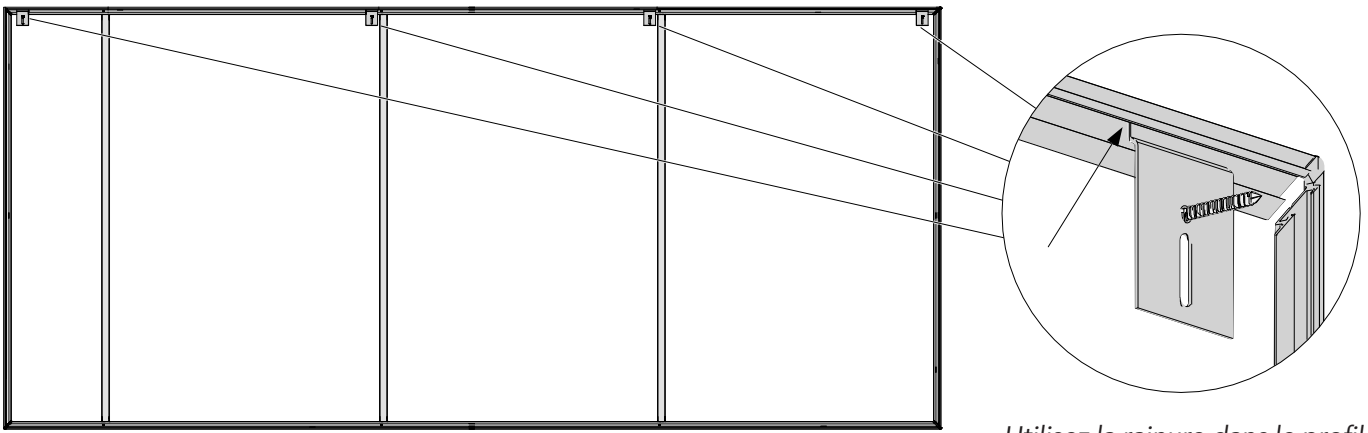

Utilisez la rainure dans le profilé.

3 Pour une installation sécurisée, tirez sur l'étiquette pour soulever la toile de l'angle.

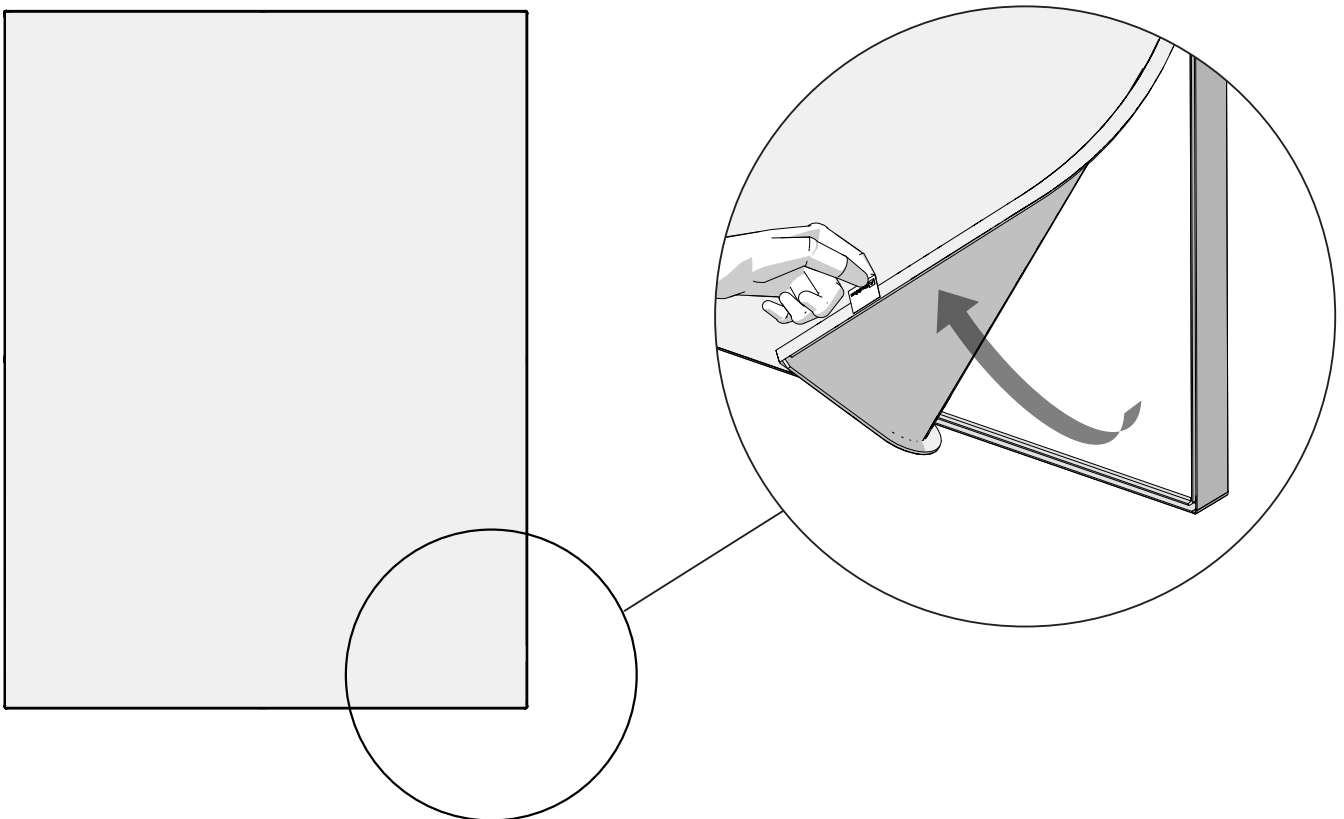

4 Percez la dalle en laine de roche et le profilé puis fixez le panneau au mur à l'aide de vis.

